



MIMOSA MALL

# Mimosa Mall

## Exhibitor Information

Voted Best Shopping Mall in Bloemfontein 2015 in the Best of Bloemfontein Reader's Choice Awards

[www.mimosamall.co.za](http://www.mimosamall.co.za) • 051 444 6914

*YourMall*





**M**imoso Mall is a Small Regional Shopping Centre and certainly a landmark in the City of Roses: Bloemfontein. Mimoso Mall is situated on the Western side of Bloemfontein and is easy accessible from the N1 via Nelson Mandela Avenue and Dan Pienaar Road and in close proximity of the University of the Free State, Medi Clinic Hospital and four of the most well known schools in South Africa: Grey College, Eunice, St Michaels and St Andrews.

Mimoso Mall is a multi – level centre with three levels of offices on top of the 2 retail floors with six parking levels providing 1900 parking bays to customers. Mimoso Mall’s unique design makes it a cosy shopping environment for the more affluent shopper with an average foot count of 720 000 per month. Bloemfontein being the Seat of the Appeal Court in South Africa and the host of the major medical - and educational institutions makes it a trading hub with strong support in a catchment area ranging up to 250 km, especially for higher order goods and specialised services. Mimoso Mall Recently underwent a multi – million rand facelift. The tiles, ceiling, light fittings and shop fronts were changed. This means shoppers can now enjoy an upgraded and trendier shopping environment as well as upgraded promotional courts.

#### DEMOGRAPHICS

Mimoso Mall draws from some 54 393 households within the primary trade area, which enjoy upper socio – economic status consisting of mixed racial profile. A high percentage

ratio of these households is economically active and academically skilled.

#### TENANT MIX

The Mall has a unique tenant mix and is anchored on the lower level by Checkers which is supplemented by most of the South African National Tenants. The upper level is flanked with a variety of offering from the Home furnishings, books, toys and coffee shops which complements the anchor Game. A brief glance at the tenant list highlights, some of the most respected names in retailing; from local flagship tenants like Checkers, Truworths, Foschini and Ster Kinekor to prestigious distinct offerings in the Free State such as Wakaberry, Typo, Cotton On and Lovisa. The mall houses a banking node, offices with a medical centre, 7 screen cinema including a 3D cinema and a variety of food offerings.

#### STATISTICS

Real evidence that this shopping centre sizzles and provides an all round shopping experience to all shoppers in the Free State:

- 1900 parking spaces
- 8.64 million visitors a year
- 110 stores covering 37 043m<sup>2</sup>
- The mall houses a banking node, offices with a medical centre, 7 screen cinema including a 3D cinema and a variety of food offerings



## FLOORING

Flooring is compulsory to all exhibitors. Exhibitor can provide own flooring, otherwise book wooden flooring directly with Mimosa Mall. R 57.50 per m<sup>2</sup>. Setup fee of R650.00

## ENTERTAINMENT

Mimosa Mall is well known for our entertainment program and high frequency of key events to promote brands stocked in Mimosa Mall as well as the platform we provide brands to co-brand our events for maximum exposure.

Our statistics of events speaks for its self and emphasize the fact that our entertainment and event area (THE MAIN ATRIUM) lay out is of such a nature that it provides the perfect set up for celebrity guest performances, black tie events, corporate functions ect only to name a few:

- The Wedding Design Expo: 2009 – 2014 Fully booked every year with over 70 exhibitors and entertainment from top-class artists.
- Food Loves Fashion Week 2013 & 2014: (Nominated for an International Solal Award)
- Fly the Flag day 2010 – 600 guests
- Barney (Licensed Character): 10 Shows in 4 days, 350 guests per show
- Golden Footprint Awarded Event Chocolat @ Mimosa Mall (South Africa's only Chocolate, Coffee & Tea Festival)
- Tummy 2 Toddler Expo: since 2010 with well-known Kids Entertainment Artisits such as Carike Keuzenkamp, Nadine Blom etc.
- Mimosa Mall Motor Expo

## FOOT COUNTERS

**A few statistics regarding Mimosa Mall:**

Monthly Foot count: 720 000 visitors per month

People flow into Mimosa Mall between 12:00 – 15:00

2400 - 2820 average people per hour on a normal day

4500 average people per hour on a busy day and / or with a event in Mimosa Mall.

## Average stay per client:

During the week – 75 – 80 min

During a weekend – 85-90 min

## TRADING HOURS

Monday – Friday	09:00 – 18:00
Saturday	09:00 – 17:00
Sunday	09:00 – 14:00
Public Holidays	09:00 – 14:00
Restaurants	Open till late



## BENEFITS & FEATURES OF EXHIBITING AT MIMOSA MALL

- Create instant revenue with direct sales from a captive audience.
- Remind consumers about existing products.
- Look & Feel: Allow potential consumers to experience the quality of your product.
- Build Brand Awareness by placing your product firmly in the minds of consumers.
- Interact with your client and target audience on a face to face level and conduct valuable market research.
- Generate Customer Loyalty: By strengthening your relationship with key consumers.
- Product Launches: The ideal platform to introduce new products into the market.

# MAIN ATRIUM (SL1)

**Surrounding Shops:**  
Queenspark, HDL, Foschini.  
(Visible from Upper and Lower Retail Levels)

**Rates:**  
**Week**  
R20 000

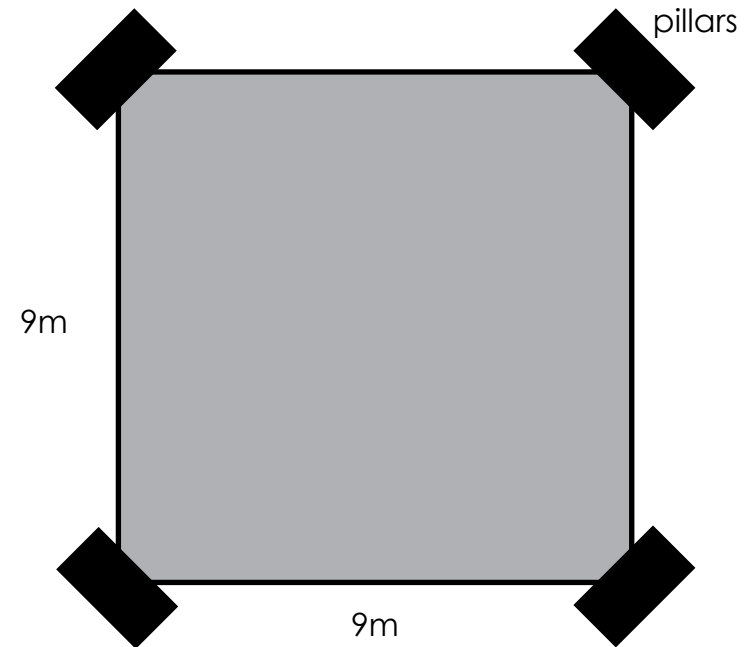

# GAME COURT (SL2)



FRONT OF GAME COURT



BACK OF GAME COURT

**Surrounding Shops:**  
Game, EVO, MTN, Vodacom, Cell C

**Rates:**

**Week**

Front of Game Court: R12 900

Back of Game Court: R9 000

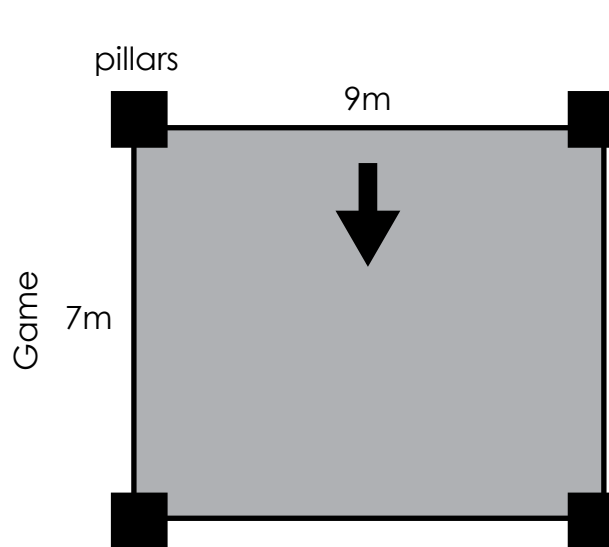

FRONT OF GAME COURT

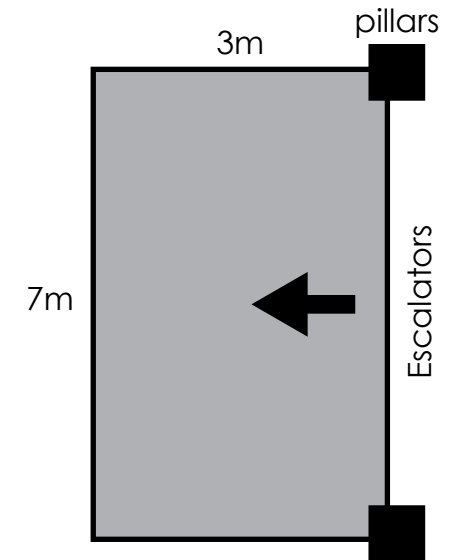

BACK OF GAME COURT



# MUGG N BEAN COURT (SL1)



## Surrounding Shops:

Clicks, Sunglass Hut, Wimpy, Mugg n Bean

## Rates:

### Week

R8 500

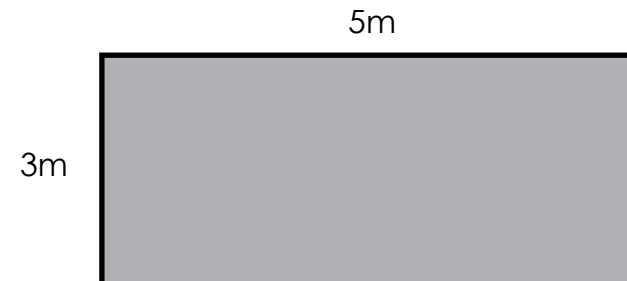

YourMall

# MR PRICE HOME COURT (SL1)

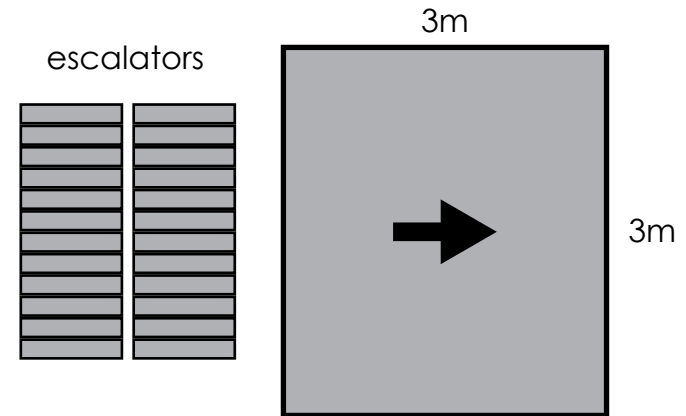

## Surrounding Shops:

Mr Price Home, Biagi's, Mugg n Bean, Information Desk

## Rates:

**Week**  
R7 900



# CLICKS COURT (SL1)



## Surrounding Shops:

Clicks, Sunglass Hut, Biagis, Wimpy

## Rates:

**Week**

R4 000

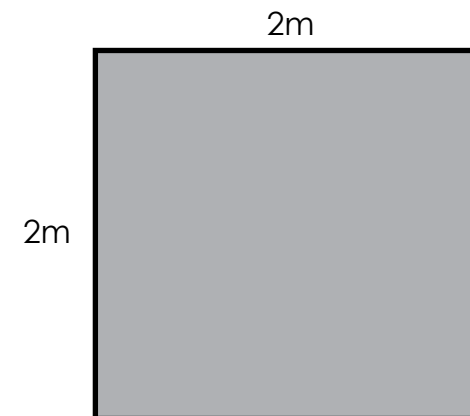

# DSO COURT (SL2)

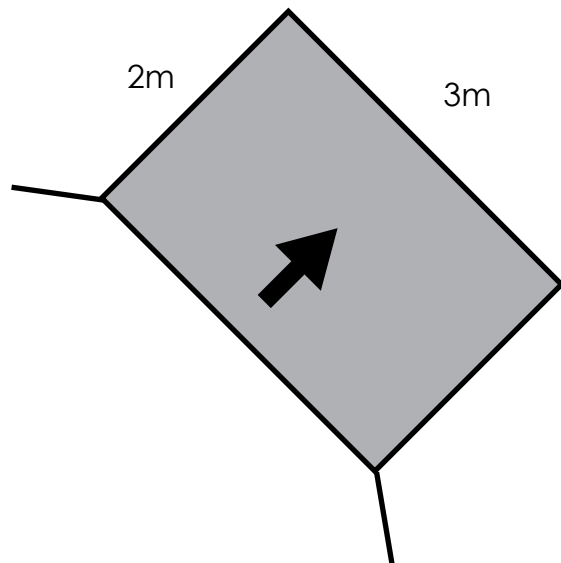

## Surrounding Shops:

Cotton On, Designer Shoe Outlet, Fego Caffe, Exclusive Books, Cotton On

## Rates:

**Week**  
R4 500

# SPORTSCENE COURT (SL1)

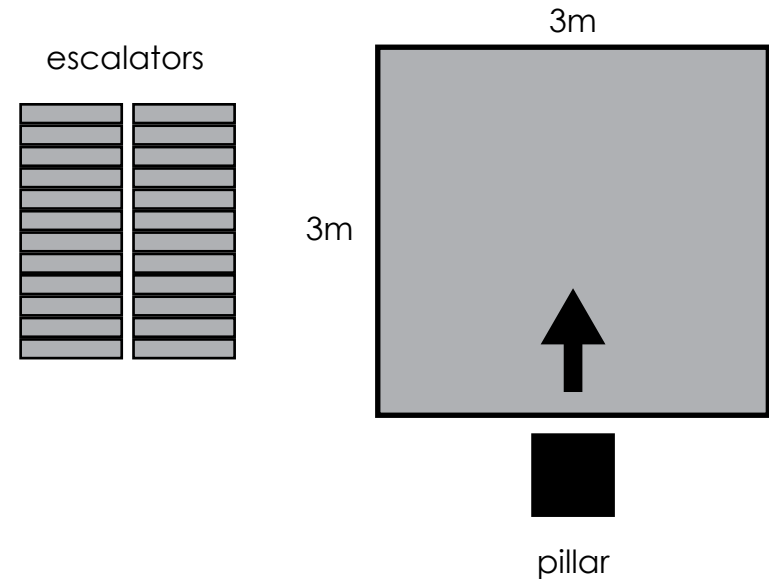

**Surrounding Shops:**  
Sports scene, Markham, Options, Truworths

**Rates:**

**Week**  
R6 900

# GALAXY COURT (SL2)

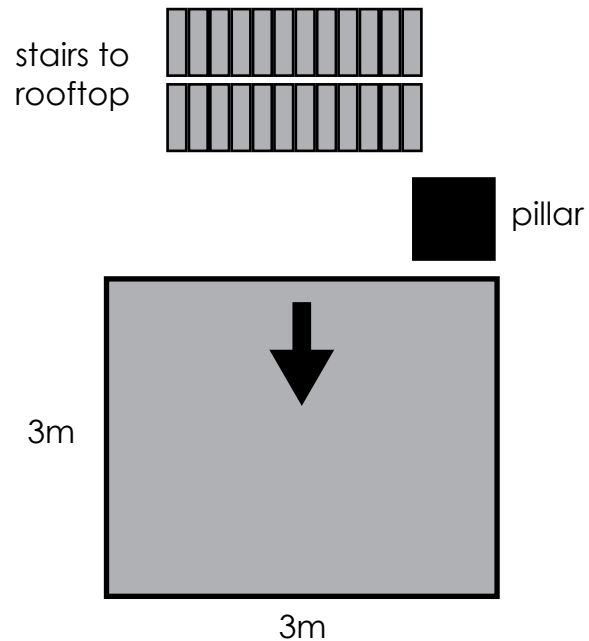

**Surrounding Shops:**  
Galaxy Co, Red Square, Cross Trainer  
Cotton On

**Rates:**  
**Week**  
R4 900



# MIMOSA MALL

## RATES – COURT SPACE

Court	Size	Revised Price
Main Atrium	81sqm (9x9)	R 20 000,00
Game Court Front	48sqm (7x9)	R 12 900,00
Game Court Back	21sqm (7x3)	R 9 000,00
Galaxy Court	9sqm (3x3)	R 4 900,00
DSO Court	6sqm (2x3)	R 4 500,00
Mr Price Home Court	9sqm (3x3)	R 7 900,00
Mugg & Bean Court	15sqm (5x3)	R 8 500,00
Sportscene Court	9sqm (3x3)	R 6 900,00
Clicks Court	4sqm (2x2)	R 4 000,00

## BOOKING TERMS

- FICA documentation is required upon each booking, including Public Liability to the value of R5 million.
- A Full proposal and visual with scale drawings needs to be submitted for management approval.
- The booking form which includes all rules and regulations needs to be completed and signed.
- Only once a contract is signed and returned to Mimosa Mall Exhibition Manager the booking will be confirmed.

- Set Up time: Mondays evenings AFTER trading hours.  
Tuesday mornings BEFORE trading hours.

- Break Down time: Monday evenings AFTER trading hours.  
Tuesday mornings BEFORE trading hours.

- Mimosa Mall Trading hours:

Mondays to Thursdays	09:00 – 18:00
Fridays	09:00 – 20:00
Saturdays	09:00 – 17:00
Sundays	09:00 – 14:00

# THANK YOU

Kind Regards,

**Donovan Burger**

***Exhibition Coordinator***

Tel: 051 444 6914 | Fax: 051 444 6918 | Cell: 079 500 2946

donovan@mallspacemanagement.co.za

# QUEENSPARK COURT (SL1)

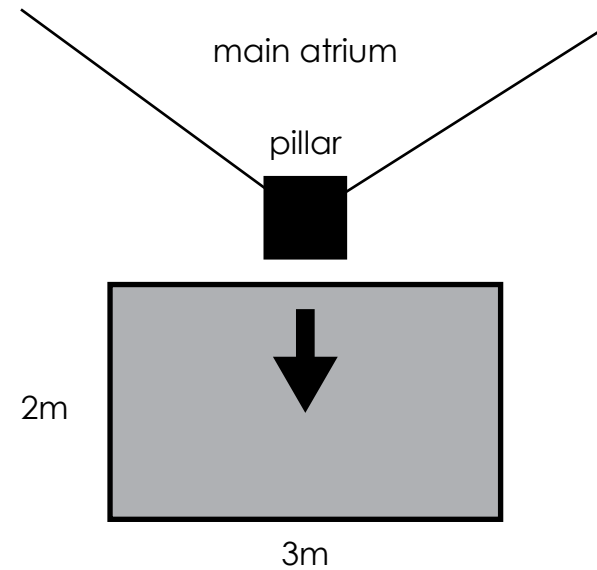

**Surrounding Shops:**  
Queenspark, Foschini, Sterns, HDL

**Rates:**

**Week**  
R4 900





# MIMOSA MALL

## RATES – COURT SPACE

Court	Size	Revised Price
Main Atrium	81sqm (9x9)	R 20 000,00
Game Court Front	48sqm (7x9)	R 12 900,00
Game Court Back	21sqm (7x3)	R 9 000,00
Galaxy Court	9sqm (3x3)	R 4 900,00
DSO Court	6sqm (2x3)	R 4 500,00
Mr Price Home Court	9sqm (3x3)	R 7 900,00
Mugg & Bean Court	15sqm (5x3)	R 8 500,00
Sportscene Court	9sqm (3x3)	R 6 900,00
Clicks Court	4sqm (2x2)	R 4 000,00